

Engineering Submittal Form – MA-6SF4

CERTIFIED FOR:

Job Name:	Customer Name:
Location:	Customer P.O.:

Recommended Usage:

Use as a free standing; non-penetrating support stand for Single or Multiple runs of piping, conduit, duct, refrigeration lines, solar panels, cable trays and equipment supports. Accepts industry standard accessories.

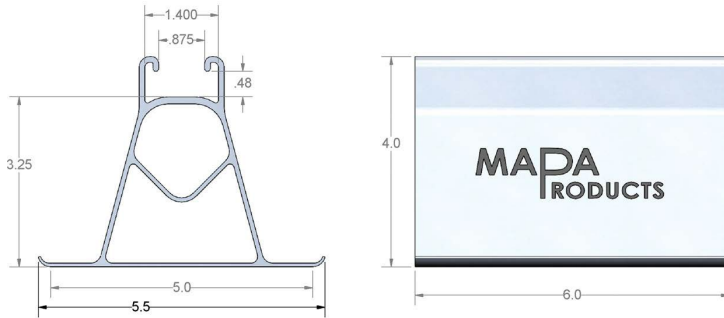

Standard Composition: Extruded Aluminum with integrated 1 5/8" shallow strut, Solid flat base with rolled edges. Available lengths pre-cut up to 10'. 100% recyclable material. Made in USA.

MAPA Products Supports are designed and manufactured in accordance with MSS SP-58-2002 and MSS SP-69-2002.

Refer to MAPA Products "Recommended Installation Guidelines" for standard installation and spacing recommendations.

Composition:

Extruded Aluminum w/ Integrated 1 5/8" shallow strut
 Strut Length 6"
 Base Dimensions 5" X 6"
 Footprint 30 sq in.
 Load Factor 5 PSI

Optional Accessories:

- Add Suffix "P" Standard pad.
- MWP1010- 9.2mm thick rubber walk pad
- Snap-N-Strut Clamps (Refer to SNS selection chart for sizing)

Certification Data

Support Pad Options							
QTY	NP	P	WP	SNS Selection	Pipe Size	Service	Notes & Options
	<input type="checkbox"/>	<input type="checkbox"/>	<input type="checkbox"/>				
	<input type="checkbox"/>	<input type="checkbox"/>	<input type="checkbox"/>				
	<input type="checkbox"/>	<input type="checkbox"/>	<input type="checkbox"/>				
	<input type="checkbox"/>	<input type="checkbox"/>	<input type="checkbox"/>				
	<input type="checkbox"/>	<input type="checkbox"/>	<input type="checkbox"/>				

DRAWN				CHECKED		DATE	DWG.NO.
							Doc. #: M-13801